

NatCen

Social Research that works for society

WebCATI at NatCen

Peyman Demstani, Maya Agur
NatCen Social Research

IBUC 2012



Overview

- WebCATI – Researcher's point of view
- How does it work
- A look to the future

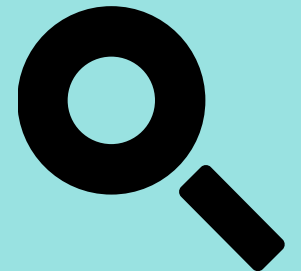

Case Study – The Evaluation of Children’s Centres in England

- Survey of centre leaders
- Same tool for web and CATI
- Flexible approach for filling in the questionnaire online
- CATI follow up to confirm contact

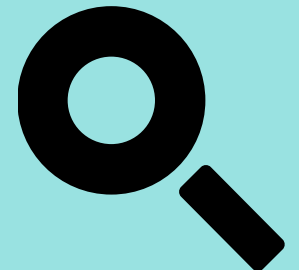

Why use WebCATI in surveys?

- Maximise cost-effectiveness
- Maintain high response rates
- Ensure population coverage
- Offer flexibility to respondents in engaging with the survey

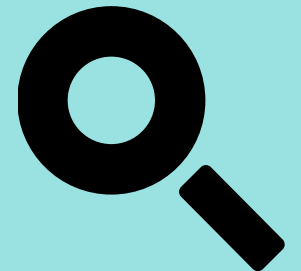

One instrument - Challenges

- Longer development time
- Question wording
- Interviewer training

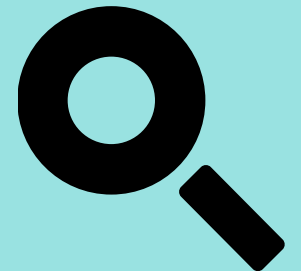

Working with a Web instrument

- Program updates during fieldwork
- Dealing with missing data
- Monitoring fieldwork progress

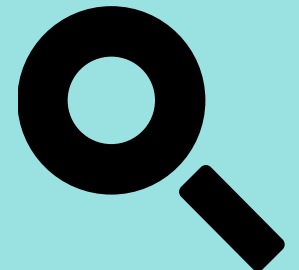

What is WebCATI at NatCen Social Research

What is WebCATI at NatCen Social Research

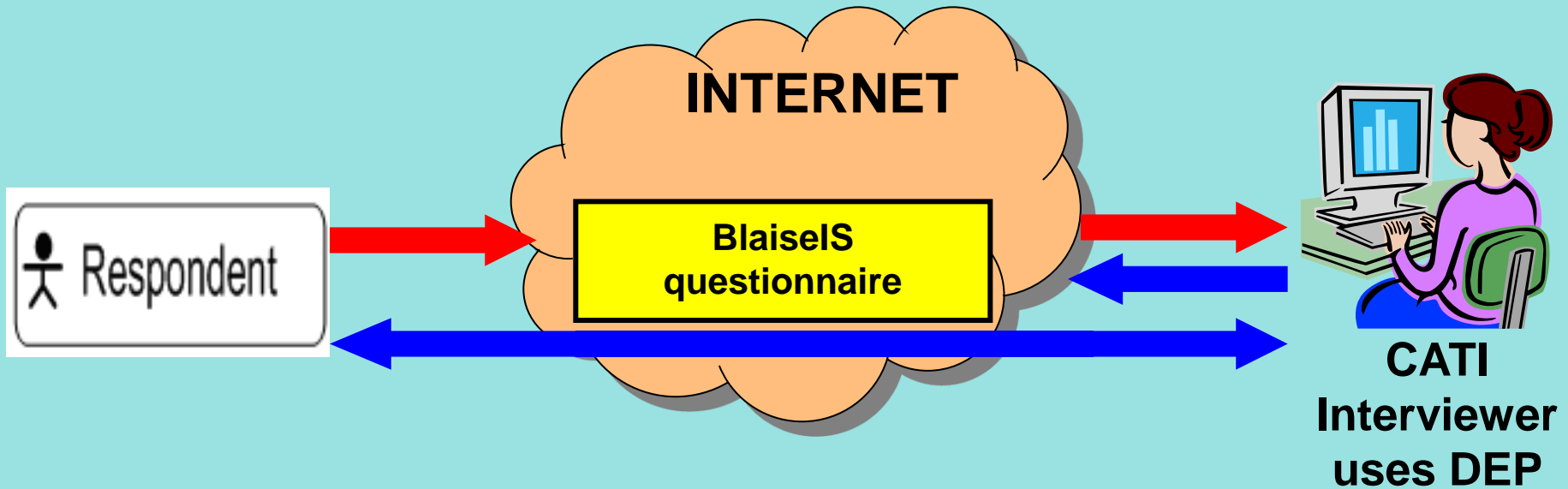

Resources

- A call centre with 40 work stations
- A dedicated server running Blaise 4.8.2 services
- A third party remote web server
- A secure FTP server
- A small team of programmers

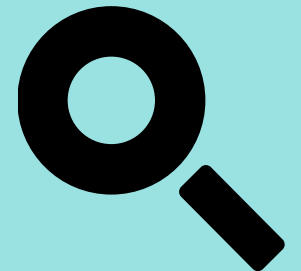

Passing parameters from DEP to BlaiseIS

Command Line String

Password

+

Mode Flag

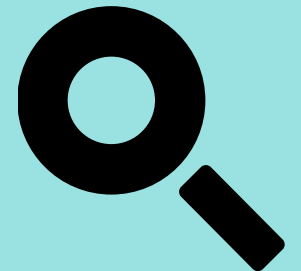

Blaise Syntax for passing parameters

```
PROCEDURE RunWeb
PARAMETERS
  IMPORT pStart : STRING
  ALIEN('WebProcs.msu', 'doAll')
ENDPROCEDURE
```

FIELDS

```
StartWeb "Do you want to start " : STRING[100]
ShowWeb "INTERVIEWER: DO YOU WANT TO DO THE WEB SURVEY": (Yes, No, Done")
```

RULES

```
StartWeb.Show
ShowWeb
IF (ShowWeb = Yes) THEN
  StartWeb := 'http://www.myserver.co.uk:80/project/survey.asp?KeyValue=' + {passw} + '&CATIX=1'
  Runweb(StartWeb)
  Showweb := Done
ENDIF
```

How does it work?

- DEP calls Internet explorer and passes control to BlaiseIS running on the third party web server

WebCATI Summer of 16 - Version P1a

Forms Answer Navigate Options Help

Do you want to do the web survey now
<http://www.natcen-surveys.co.uk:80/TUTestSummerof16/p3087.asp?KeyValue=AA11AA&CATIX=1>

INTERVIEWER: CODE 'Yes' IF YOU WANT TO ACCESS THE WEB QUESTIONNAIRE

1. Yes
 2. No

AAADDPC
CONADD
Intro2 1 Cont
StartWeb <http://www.natcen-surveys.co.uk>
ShowWeb  Done

4/8 | P3087 | 999900001 | QStart.ShowWeb | 09/03/2012 | 14:58:52

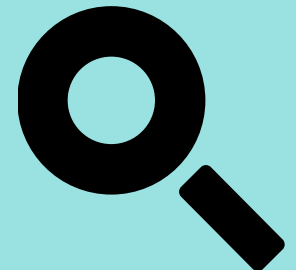

Passing parameters from DEP to BlaiseIS

Command Line String

Password

+

Mode Flag

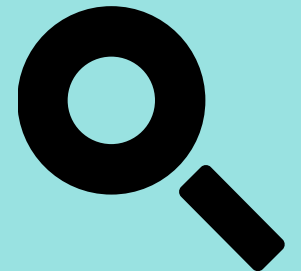

Passing parameters from DEP to BlaiseIS

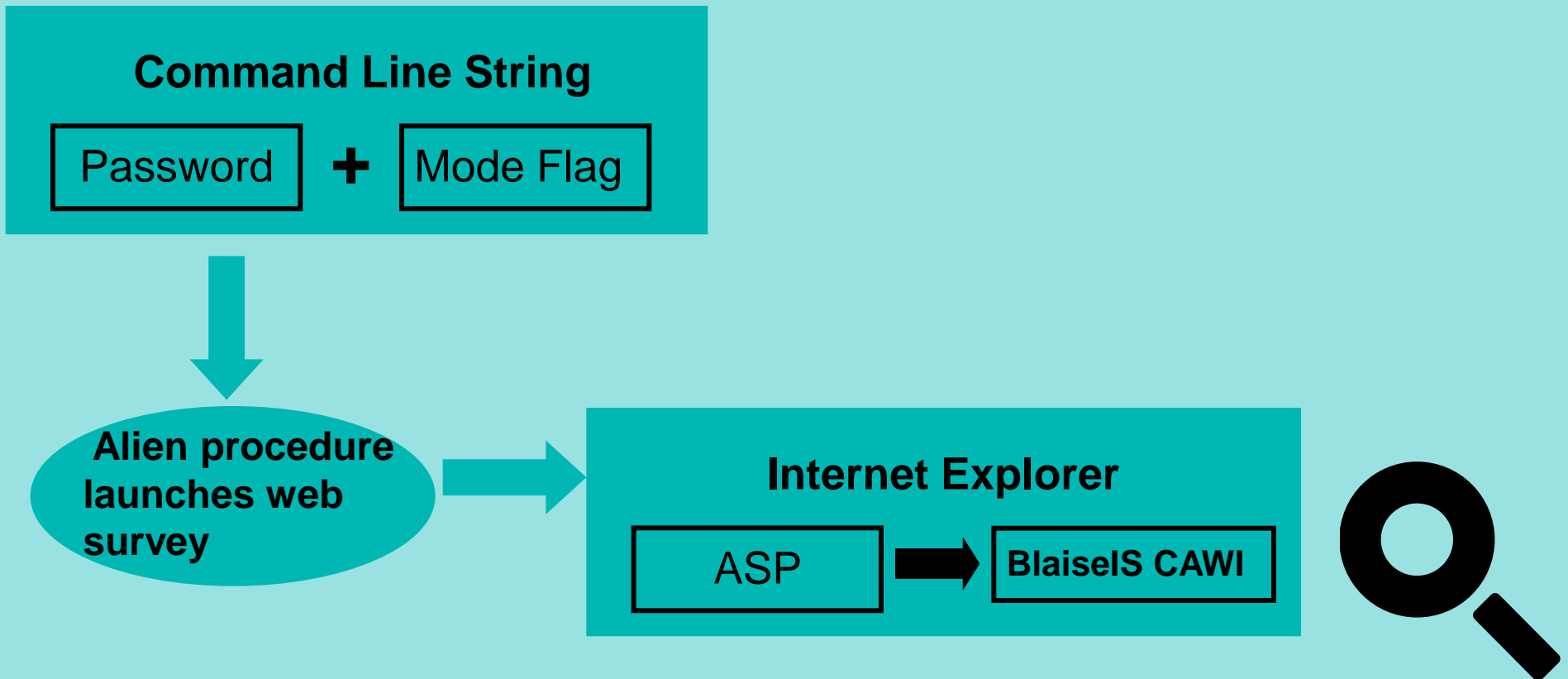

Passing parameters from DEP to BlaiseIS

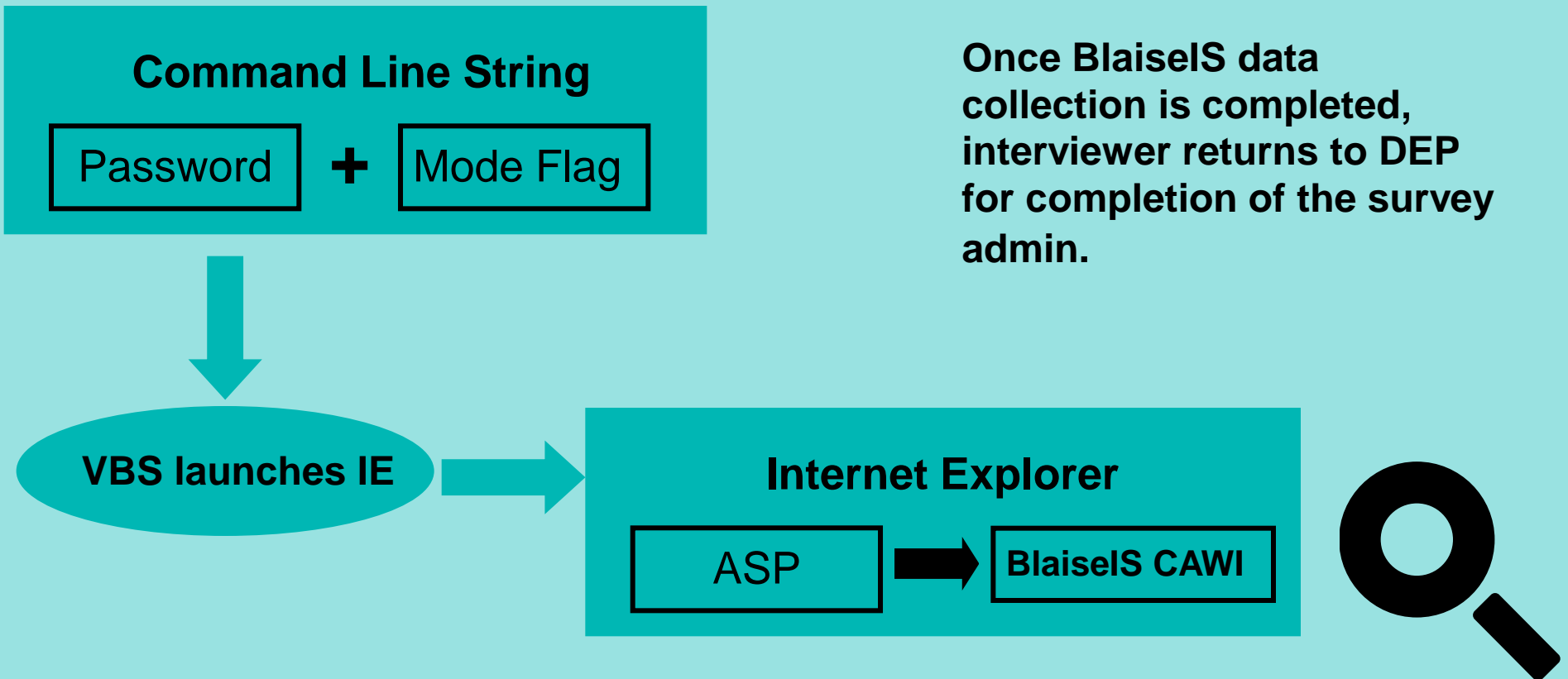

File transfer between remote server and LAN

External Web Server

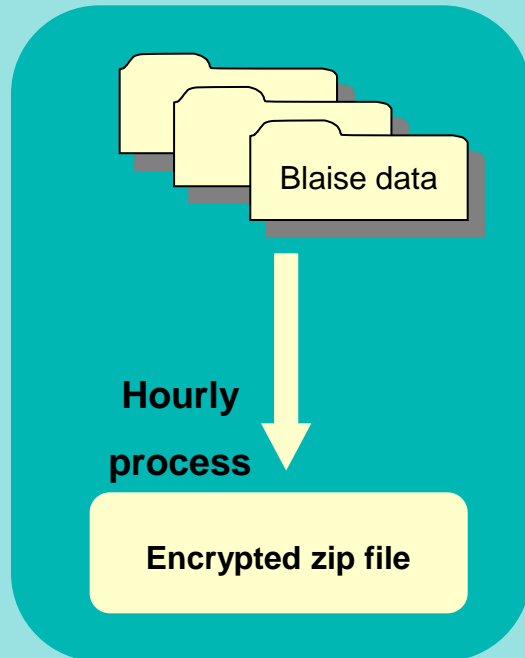

File transfer between remote server and LAN

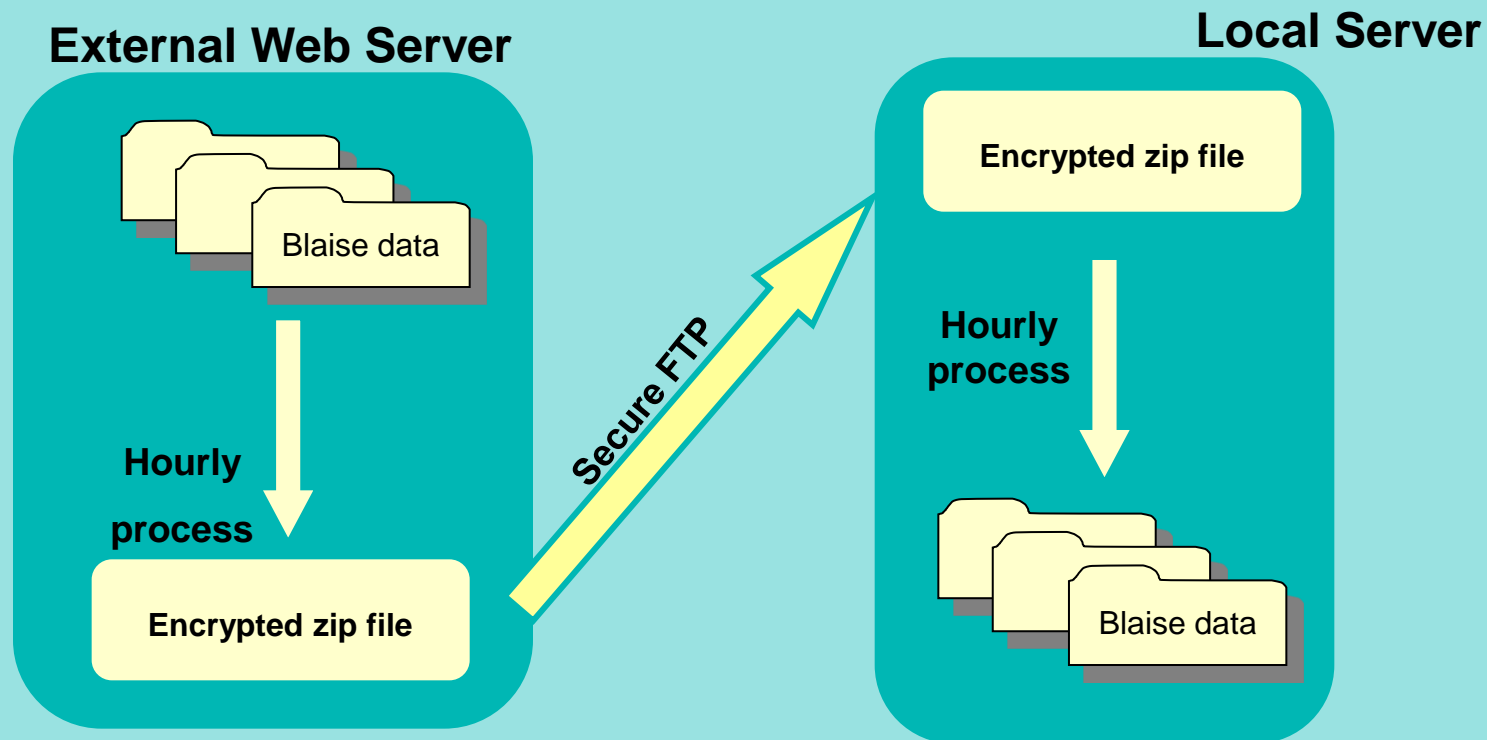

File transfer between remote server and LAN

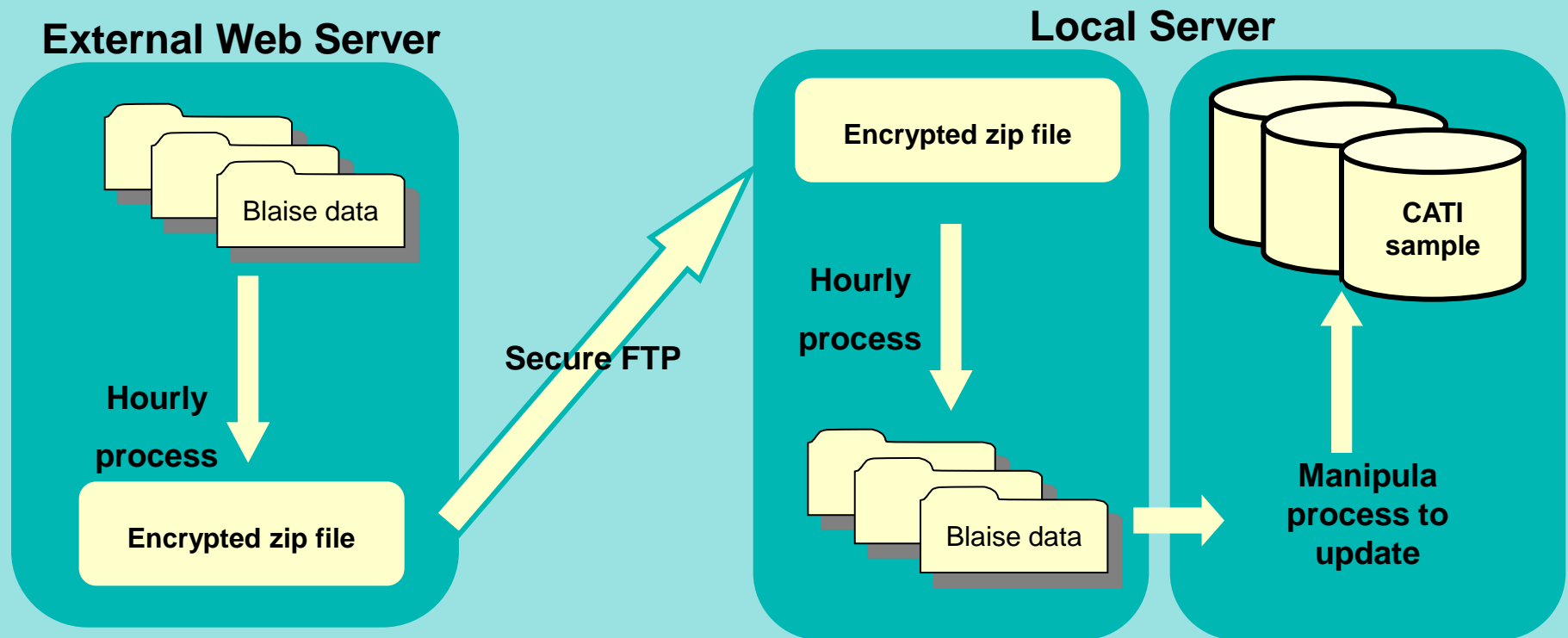

Issues and concerns

- CATI Service and lock files

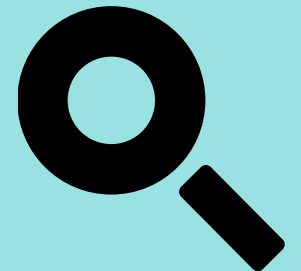

Issues and concerns

- CATI Service and lock files
- Out of Office Hours Support

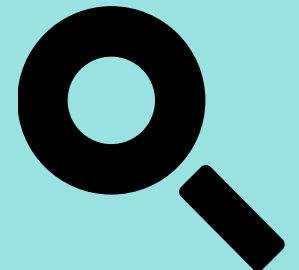

Issues and concerns

- CATI Service and lock files
- Out of Office Hours Support
- Information Security

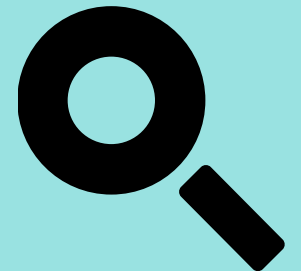

Issues and concerns

- CATI Service and lock files
- Out of Office Hours Support
- Information Security
- Para-data information

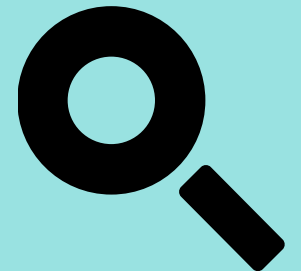

Summary and Current Status

NatCen's Servers and Data Flow Diagram

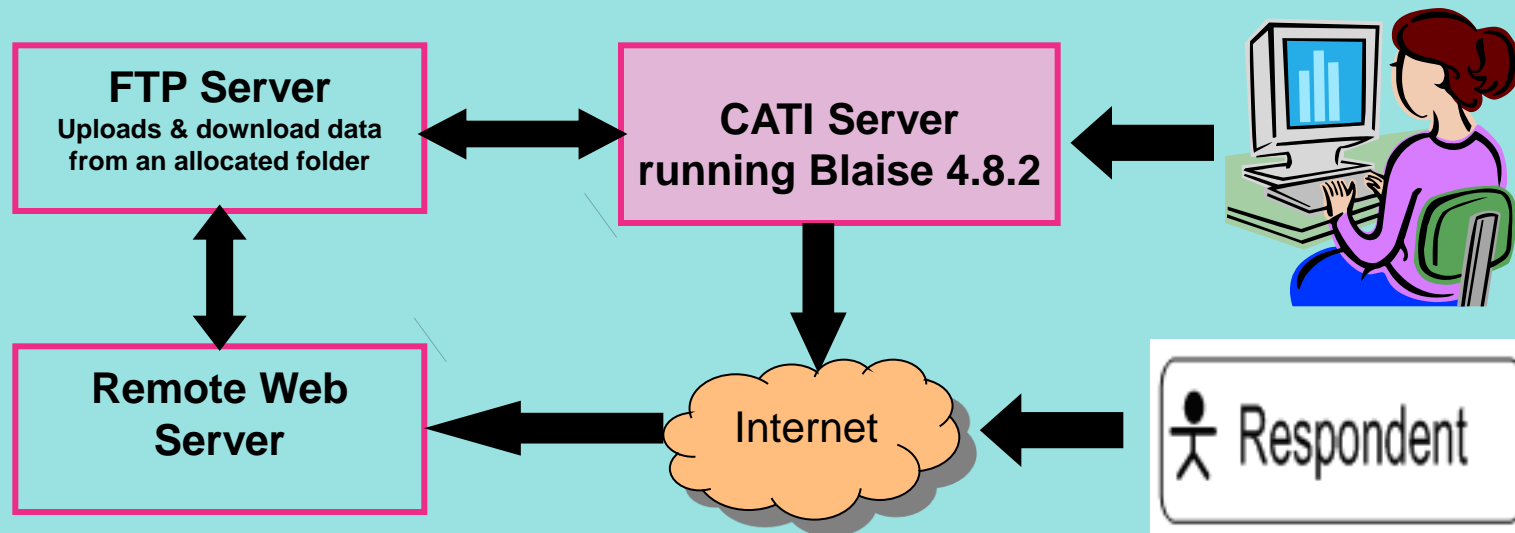

Current Status

NatCen's Servers and Data Flow Diagram

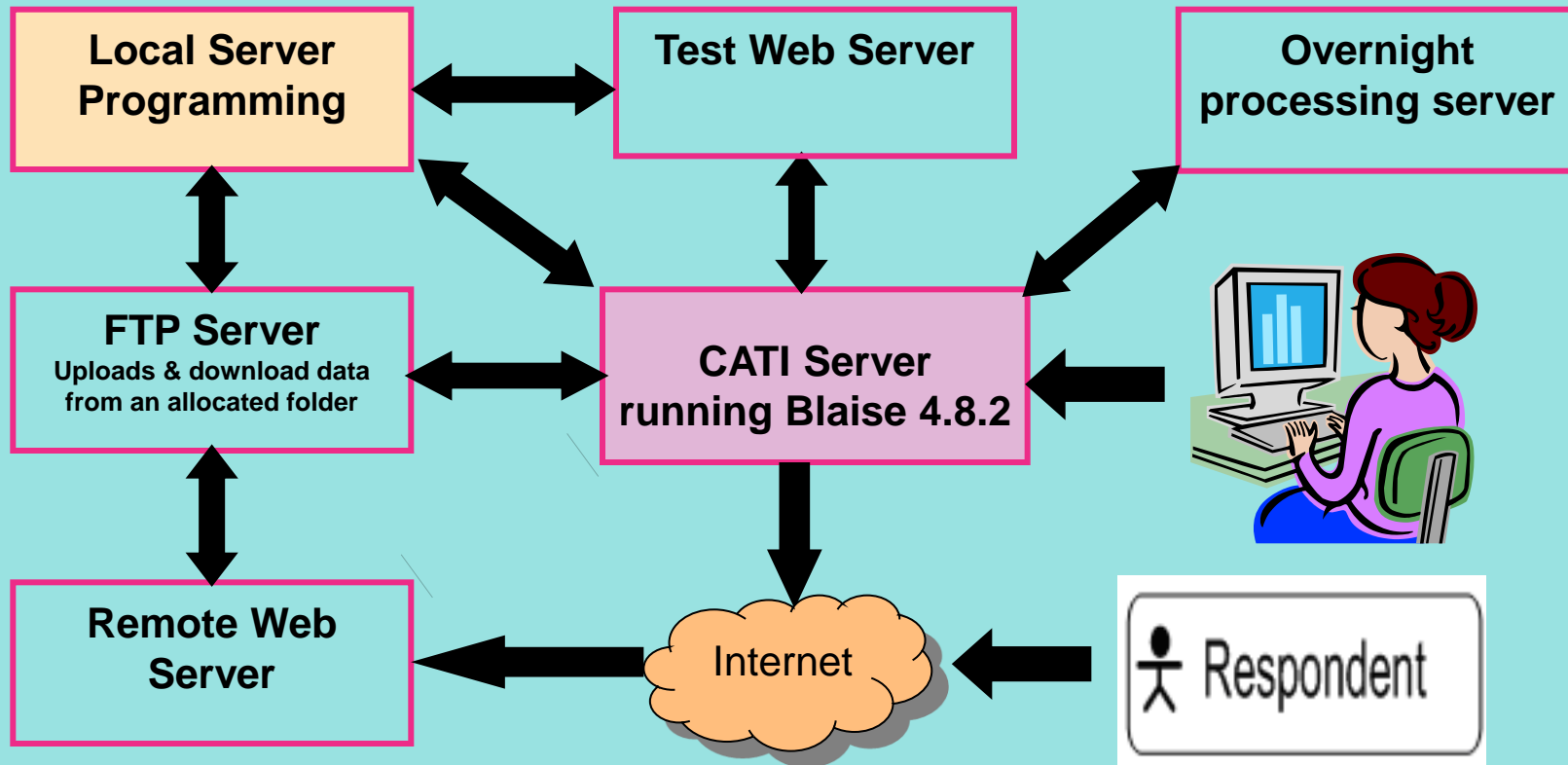

Future

- NatCen Hosted Web Server
- Upgrade to 4.8.4
- Multimode Case Management System
- Online Reports

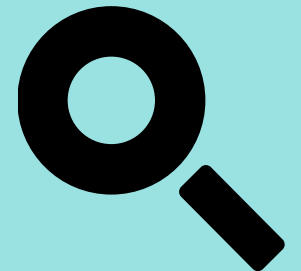

Thank you

Peyman Damestani

peyman.damestani@natcen.ac.uk

Maya Agur

maya.agur@natcen.ac.uk

Visit us online at www.natcen.ac.uk

NatCen

Social Research that works for society

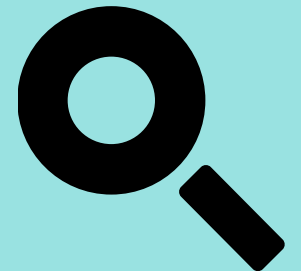

NatCen
Social Research